

User's Manual

Package Contents

- Data Logger (TR41/42/45) • Lithium Battery LS14250 • Registration Code Label • Strap • User's Manual (Warranty Included)
- Temperature Sensor TR-5106 (TR42 only) • Cable Clamp (TR45 only)

Device Setup

Battery Installation

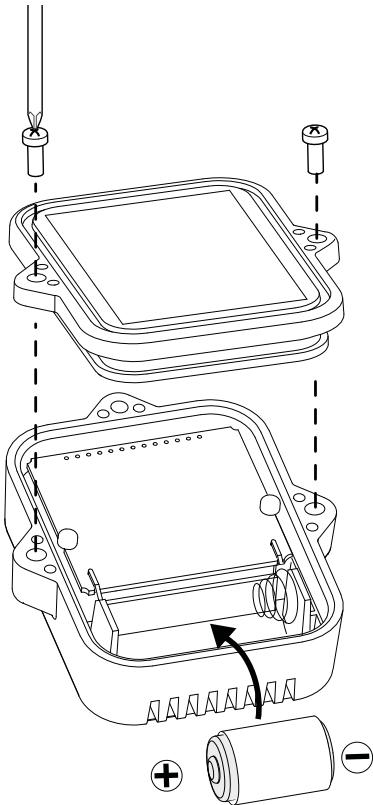

TR42 Sensor Connection

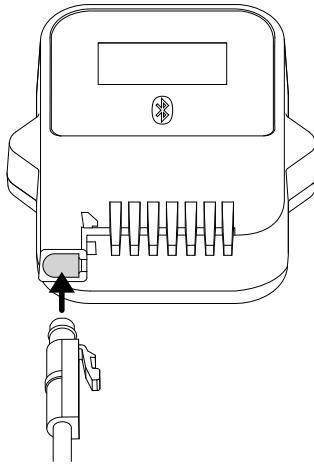

TR45 Pt Sensor Connection

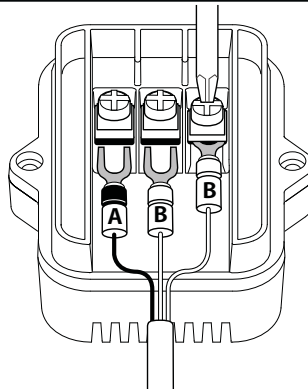

TR45 TC Sensor Connection

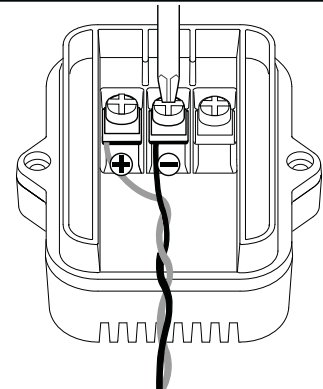

Installation of the ThermoREC App

ThermoREC is a mobile app used for setting up the TR4, monitoring of real time data, collecting and uploading recorded data to the cloud directly from your smartphone or tablet.

ThermoREC can be found on the Google Play Store and the App Store.

MEMO

For detailed information and troubleshooting, please access the following URL:
<http://www.tandd.com/r/help/tr4>



Bluetooth Thermo Recorder **TR41/TR42/TR45** Warranty

Provisions for Free Repair

1. If the product does not work properly despite the fact that the customer used it properly and in line with the directions found in the documentation for the concerned product, the product shall be repaired free of charge through the distributor which sold the product.
2. If the customer requests free repair because of trouble within the warranty period, bring or send the product along with the warranty to the distributor.
3. If you have moved after purchasing, or there are difficulties contacting the distributor from which you purchased the product, please contact T&D directly for service.
4. Free repair is not available in the following cases even though it is within the warranty period:
 1. Trouble or damage was caused by careless operation, natural disaster, fire, public pollution, or use of a power source other than specified.
 2. If repair, adjustment, disassembly or modification of the product has been carried out by a person other than a T&D authorized engineer.
 3. Trouble or damage was caused by transportation, movement or dropping of the product after purchase.
 4. Failure to submit the warranty or failure to fill in all items required in the warranty.
5. The warranty cannot be reissued.

This warranty only promises customers free repair within the period and under the conditions clarified in this warranty. Therefore, the customer's legal right will not be limited by this warranty. For further information on repair and other service questions after the termination of the warranty period, contact your local distributor or T&D Corporation.

T&D CORPORATION



www.tandd.com/

Safety Precautions and Instructions



The following items should be strictly obeyed for the safe usage of this product, and for protecting yourself and other people from bodily harm and/or damage to property.

Explanation of Symbols

















Warning Symbols

 DANGER	These entries are actions that absolutely under no circumstance should be taken. The taking of such an action may cause serious personal physical damage or death.
 CAUTION	These entries are actions that if taken may lead to physical injury or damage to persons or things.

Picture Symbols

 Denotes an important warning or caution.	 Denotes a forbidden action.	 Denotes an action that should be carried out.
--	---	---

DANGER To Prevent Serious Accidents

-  Do not disassemble, repair or modify the unit.
-  Do not use the unit in any environment that is exposed to chemicals and harmful gases. Doing so may cause corrosion and/or other danger to the unit. Also, coming in contact with hazardous substances may cause bodily harm to the user or people nearby.
-  If water or a foreign substance enters the case, this may cause malfunction, damage, and/or unexpected accidents. If this occurs, immediately remove the battery and stop using the unit. If the unit is subjected to significant temperature change while wet, it may cause condensation inside the case.
-  Do not handle the unit, remove the battery or sensor with wet hands.
-  This product has been designed for private and/or industrial use only. It should not be used in situations where strict safety precautions are necessary such as with medical equipment, or in systems directly or indirectly connected with human life or well-being.
-  Do not drop or expose the unit to a strong impact.
-  Do not cut or process the sensor cables. Also, do not twist, pull or swing any of the cords or cables.
-  To prevent damage to the unit from static electricity, remove static electricity from your body by touching metal around you (such as a door knob and window frame) before touching the unit.
-  Store the unit and battery out of the reach of children.
-  We are not responsible for any damage, malfunction or trouble, whether direct or indirect, caused by the use of our product.
-  Do not use any power or sensors other than those specified by T&D Corporation.
-  Make sure the sensor is inserted fully, so as not to cause an improper connection. Also, when unplugging the sensor from the unit, do not pull the cord, but hold the connector to disconnect.
-  If the unit produces heat, emits smoke or a strange smell, or makes unusual noise, immediately remove the battery and stop using it.
-  To maintain waterproof capacity, we suggest periodically changing the parts inside the case (Optional Maintenance Set TR-00P1).
-  Contact with oil may cause cracks to appear in the casing of the unit. When using this unit in environments where such oils are present, please insure that it is protected from contact through use of a polyethylene bag or other means.
-  Do not remove or reinsert the battery once it has been set; continue using until battery power is depleted. Always use a new battery for replacement.

CAUTION Do not place or store in the following areas:

- Areas exposed to direct sunlight
- Areas subject to direct flames or heaters, as well as areas in which hot air accumulates and creates extremely high temperatures
- Areas exposed to static electricity
- Areas exposed to strong magnetic fields
- Areas exposed to dampness
- Areas subject to condensation or wet areas
- Areas exposed to excessive vibration
- Areas exposed to excessive smoke, dust or dirt.

CAUTION Other Precautions

- Use the unit and the sensor in the specified operating environment, and do not use in any other purposes than those intended.
- If the unit is not to be used for a long period of time, remove the battery. If left in the unit, the battery may leak and lead to malfunctioning.
- Do not allow dust or foreign objects to get into the sensor jack.
- If the unit gets dirty, wipe it with a clean cloth.
- Battery terminals may provide insufficient contact due to age or vibration. This may lead to data loss.
- Please note that this User's Manual has been written based on the presupposition that details about set-up of any necessary mobile devices to enable network connection

have already been taken care of by the user and that connection has been confirmed as workable. T&D Corporation shall not be responsible for any damages which a contractor, a user or a third party may suffer, whether direct or indirect, due to the inability to communicate or use communication devices.

Compliance Information

For FCC Model

FCC and IC Statement

This device complies with Part 15 of FCC Rules and Industry Canada licence-exempt RSS standard(s). Operation is subject to the following two conditions: (1) this device may not cause interference, and (2) this device must accept any interference, including interference that may cause undesired operation of this device.

Le présent appareil est conforme aux la partie 15 des règles de la FCC et CNR d'Industrie Canada applicables aux appareils radio exempts de licence. L'exploitation est autorisée aux deux conditions suivantes : (1) l'appareil ne doit pas produire de brouillage, et (2) l'utilisateur de l'appareil doit accepter tout brouillage radioélectrique subi, même si le brouillage est susceptible d'en compromettre le fonctionnement.

FCC Class B Statement

This equipment has been tested and found to comply with the limits for a Class B digital device, pursuant to Part 15 of the FCC Rules. These limits are designed to provide reasonable protection against harmful interference in a residential installation. This equipment generates, uses and can radiate radio frequency energy and, if not installed and used in accordance with the instructions, may cause harmful interference to radio communications. However, there is no guarantee that interference will not occur in a particular installation. If this equipment does cause harmful interference to radio or television reception, which can be determined by turning the equipment off and on, the user is encouraged to try to correct the interference by one or more of the following measures:

- Reorient or relocate the receiving antenna.
- Increase the separation between the equipment and receiver.
- Connect the equipment into an outlet on a circuit different from that to which the receiver is connected.
- Consult the dealer or an experienced radio/TV technician for help.

To comply with the limits for the Class B digital device, pursuant to Part 15 of the FCC Rules, this device must be installed in computer equipment certified to comply with the Class B limits.

All cables used to connect the computer and peripherals must be shielded and grounded. Operation with non-certified computers or non-shielded cables may result in interference to radio or television reception.

FCC Caution:

- Changes or modifications not expressly approved by the party responsible for compliance could void the user's authority to operate the equipment.

IC Class B Statement

This Class B digital apparatus complies with Canadian ICES-003.

Cet appareil numérique de la classe B est conforme à la norme NMB-003 du Canada.

FCC/IC Radiation Exposure Statement

This equipment complies with FCC/IC radiation exposure limits set forth for an uncontrolled environment and meets the FCC radio frequency (RF) Exposure Guidelines and RSS-102 of the IC radio frequency (RF) Exposure rules. This equipment has very low levels of RF energy that is deemed to comply without maximum permissive exposure evaluation (MPE).

This transmitter must not be co-located or operated in conjunction with any other antenna or transmitter. Cet équipement est conforme aux limites d'exposition aux rayonnements énoncées pour un environnement non contrôlé et respecte les règles les radioélectriques (RF) de la FCC lignes directrices d'exposition et d'exposition aux fréquences radioélectriques (RF) CNR-102 de l'IC. Cet équipement émet une énergie RF très faible qui est considérée comme conforme sans évaluation de l'exposition maximale autorisée (MPE).

Location of FCC ID and IC Certification Number

The FCC ID and IC ID can be found inside the battery compartment of your device.

For CE Model

CE Statement

This device complies with technical specifications required under EN 300 328, EN 301 489, and EN 60950-1.

Important Notice

Wireless products cannot be used in countries other than where those products have been approved for use, according to that country's wireless regulations.

T&D Corporation shall in no manner whatsoever take responsibility for the usage of these products, nor be liable in any manner for legal consequences stemming from the usage of these wireless products in unapproved areas.

電波法に関するご注意

本製品は、電波法に基づく特定小電力無線機器として、技術基準適合証明（利用に関してはお客様の免許申請等が必要）を受けています。必ず次の点を守ってお使いください。

- 分解・改造をしないでください。分解・改造は法律で禁止されています。
- 技術基準適合ラベルをはがさないでください。ラベルのないものの使用は禁止されています。

Bluetooth low energy の電波に関して

本製品における Bluetooth low energy の使用周波数帯では、電子レンジ等の産業・科学・医療用機器のほか工場の製造ライン等で使用されている移動体識別用の構内無線局（免許を要する無線局）及び特定小電力無線局（免許を要しない無線局）並びにアマチュア無線局（免許を要する無線局）が運用されています。

1. 本製品を使用する前に、近くで移動体識別用の構内無線局及び特定小電力無線局並びにアマチュア無線局が運用されていないことを確認して下さい。
2. 万一、本製品から移動体識別用の構内無線局に対して有害な電波干渉の事例が発生した場合には、速やかに使用周波数を変更するか又は電波の発射を停止した上、下記連絡先にご連絡頂き、混信回避のための処置等（例えば、パーティションの設置など）について相談して下さい。
3. その他、本製品から移動体識別用の特定小電力無線局あるいはアマチュア無線局に対して有害な電波干渉の事例が発生した場合など何かお困りのことが起きたときは、弊社までお問い合わせ下さい。

オンラインサポート www.tandd.co.jp/support/

電波の種類と干渉距離

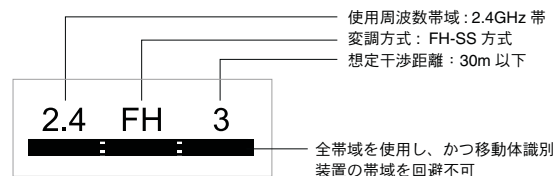

Bluetooth® のワードマークは、Bluetooth SIG, Inc が所有する登録商標であり、株式会社アンドデイはこれらのマークをライセンスに基づいて使用しています。