

Wireless Data Recorder RTR-505



User's Manual

Thank you for purchasing our product. Carefully read this instruction manual before using this Unit.

Outline of RTR-505

External Input Module Type
Splash proof (rated for use in daily life)
 RTR-505 is a Data Logger designed to measure and record different items depending on the Input Module to be connected: temperature (Thermocouple/Pt), voltage, 4-20mA, and pulse. The body is splash proof (rated for use in daily life), which can be placed in an environment between -40 and 80°C. Recorded data can be automatically collected from the RTR-505 via wireless communication with the Base Unit (sold separately), and also viewed in graph and table form as well as printed out by using the supplied software.

Package Contents:
 Data Logger (RTR-505), Tubed Lithium Battery (LS14250), Input Module(*), Strap, User's Manual (this manual including warranty)

* An Input Module included in the package differs depending upon which "set model" has been purchased.

Part Names

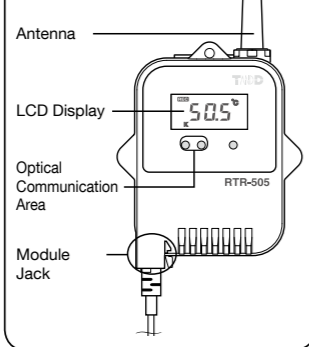

Specifications

Device Name	RTR-505 / 505L
Measurement Items (*1)	Temperature / Voltage / 4-20mA / Pulse Count
Recording Intervals	Select from 15 choices: 1, 2, 5, 10, 15, 20, and 30 sec. / 1, 2, 5, 10, 15, 20, 30, and 60 min.
Logging Capacity	16,000 Readings
Recording Mode (*2)	Endless / One Time (Factory Default Setting: Endless)
LCD Displayed Items	Measurement, Recording Status, Recording Mode, Battery Life Warning, Unit of Measurement, Full (Logging Capacity FULL), Sensor Unconnected, Input Module Unconnected, Measurement Range Exceeded, Display Range Exceeded
Communication Interfaces	Wireless Communication / Optical Communication
Wireless Communication Specifications	
RF Power	5mW
Radio Standard Specifications	ETSI EN 300-220 (Frequency Range:869.7 to 870MHz)
Transmission Range	About 150 meters (500 ft) (if direct and unobstructed)
Communication Speed	About 2 min. (when downloading 1 unit at full logging capacity)
Optical Communication Speed	About 160 sec. (when downloading 1 unit at full logging capacity at 2400bps)
Power	Lithium Battery (LS14250) L Type: Large Capacity Battery Adaptor Kit (RTR-500B1)(*3) External Power Adaptor Kit (RTR-500A2: sold separately)
Battery Life (*4)	About 10 months (for temperature measurement)
Waterproof Capacity	Splash proof (rated for use in daily life) (*5)
Dimensions	H62xW47xD19mm (excluding protrusions and sensor)
Weight	About 50g
Operating Environment	Operating Temperature Range: - 30 to 80°C (The operating temperature range and measurement range is -40 to 80°C, but wireless communication cannot occur in an environment of less than -30°C.)
Other	A Base Unit is required (sold separately). (Compatible Base Units: RTR-500NW, RTR-500AW, RTR-500, RTR-500DC, RTR-500MBS-A)

(*1) Measurement items other than Pulse will have different measurement range depending on the Input Module and sensor to be connected. For details, see the User's Manual included with the Input Module.
 (*2) Only "Endless" is available when using RTR-500W for Windows or RTR-500MBS for Windows.
 (*3) When using RTR-500B1 it is necessary to purchase Lithium Battery (LS26500). For details, contact your local authorized distributor.
 (*4) Battery life varies depending upon the ambient temperature in which it is used, the recording interval, the frequency of communication, and the battery performance. All estimates are based on operations carried out with a new battery and are in no way a guarantee of actual battery life.
 (*5) This is the waterproof capacity of a Unit with an Input Module connected.
 The specifications listed above are subject to change without notice.

1. Installing the Battery

- 1. Remove the screws and open the cover.**
Make sure to use the proper size and type of screwdriver. (Phillips head #1 screwdriver is recommended.)
- 2. Insert the included battery.**
Do not remove the battery from its tube casing.
- 3. Check the rubber packing for any cuts or scratches and close the cover as it was when opened.**
- Dust or defects on the packing can adversely affect the waterproof capacity; in this case, remove the dust or replace the packing if it is damaged.
- Be sure to completely close the cover.
- Make sure not to over tighten the screws.
(Appropriate Tightening Torque: 20N-cm to 30N-cm(2Kg-fcm to 3Kg-fcm))

Notes about Battery Installation

- After inserting the battery for the first time, nothing may appear or occur for about 10 seconds; this is not a malfunction.
- If a new battery has been installed and nothing appears in the display, please remove and reinsert the battery.
- When inserting a battery, make sure no water or foreign objects get inside the case.
- Make sure that + and - are in the correct direction.

About Lithium Batteries

- When using an LS14250 type lithium battery, even though a new battery has been inserted the battery warning mark may remain on for a short time. This is due to a special characteristic of the battery. Note that the longer the battery has been in storage the longer the amount of time, from 10 minutes to about 1 hour, the battery warning mark will remain on. If during that time the Base Unit is used to get the current status of the Remote Unit, the remaining battery level will show that the battery level is low.
- Please store the LS14250 in a place that is 20°C or less.
- The estimated battery life of the Lithium Battery LS14250 is about ten months if recorded data is downloaded once a day or the monitoring occurs once every 10 minutes.
- When using lithium batteries other than LS14250 produced by SAFT, such as CR2, product specifications cannot be guaranteed nor can the performance of some functions, such as the battery warning function.
- Please avoid using the CR2 in the following situations:
Using the unit in an environment below 0 °C or above 60 °C
Exposing the CR2 to continuous vibration such as in transportation
- When using a CR2 lithium battery, the tube is not necessary.
- To maintain waterproof capacity, when changing batteries also change the rubber packing and the drying agent (silica gel). When using a CR2 lithium battery, please purchase the optional Maintenance Set (TR-00P1) to replace the rubber packing and silica gel.

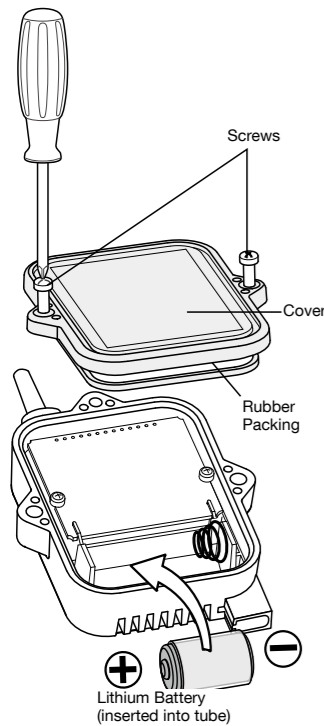

2. Connecting an Input Module

Insert an Input Module into the module jack. Once the Unit recognizes the module, the LCD display will change as shown below and recording will start. (If you have purchased an RTR-505-P, the Unit has been set by default to start recording upon installation of the battery.)

- The factory default settings are as follows: Recording Interval:10 minutes, and Recording Mode: Endless.

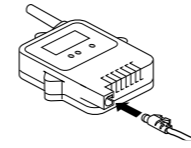

Make sure that the module is completely inserted until you hear a "click" sound.

Set Model Number	Measurement Item	Input Module	LCD Displayed Items (see the following section #3)
RTR-505-TC	Temperature (Type K, J, T, S)	Thermocouple Module (TCM-3010)	Measurement, Unit of Measurement, Sensor Type, Operational Status
RTR-505-Pt	Temperature (Pt100, Pt1000)	Pt Module (PTM-3010)	Measurement, Unit of Measurement, Sensor Type, Operational Status
RTR-505-V	Voltage	Voltage Module (VIM-3010)	Measurement, Unit of Measurement, Operational Status
RTR-505-mA	4-20mA	4-20mA Module (AIM-3010)	Measurement, Unit of Measurement, Operational Status
RTR-505-P	Pulse	Pulse Input Cable (PIC-3150)	Measurement, Unit of Measurement, Operational Status

3. How to Read the LCD Display

When being used in very hot or cold environments the display may become difficult to read. This is not a malfunction.

Basic LCD Display

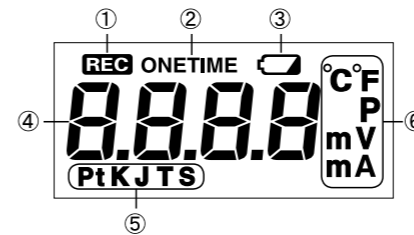

- 1 [REC] Mark**
The recording status will appear.
ON: Recording in progress
BLINKING: Waiting for programmed start
- 2 [ONETIME] Mark**
When the recording mode is set to "One Time", this mark will appear. The factory default setting is "Endless" and this mark will not appear.
- 3 Battery Warning Mark**
When it is time for the battery to be replaced, this mark will appear.
- 4 Measurements and Messages Area**
Measurements or operational messages will appear here.
The type of sensor connected to or set in the Unit will appear.
- 5 Sensor Type**
Thermocouple Sensor: K, J, T, S
Platinum Thermal Resistance Sensor: Pt (Pt100), PtK (Pt1000)
- 6 Unit of Measurement**
The unit of measurement for the display will appear.

Battery Replacement

1. When it is time for the battery to be replaced, a battery warning mark will appear.



Please replace the battery as soon as possible if this mark appears.

2. If you do not change the battery and continue using the Unit, the measurement display will intermittently display [bAtt].

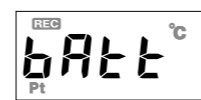

- After this point the downloading of data can no longer be done via wireless communication.
- Without changing the battery and attempting to use optical communication to download recorded data, the communication may be broken and if so all recorded data may be lost.
- Recording will be continued.

3. If the battery is further left unchanged, the display will automatically shut off.

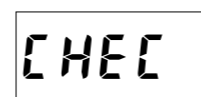

If, at this time, a new battery is placed in the Unit, [CHEC] will appear on the display after which recording will begin again using the previously set recording conditions. Note however that all previously recorded data will have been lost.

Estimated Battery Life

When a battery warning mark appears, try to replace the battery with a new one as soon as possible.

In a normal temperature environment, where recorded data is downloaded once a day or if monitoring is carried out once every ten minutes:

Set Model Number	Battery Life (Recording Interval: 10 seconds or longer)
RTR-505-TC	About 10 months
RTR-505-Pt	About 10 months
RTR-505-V	About 10 months
RTR-505-mA	About 10 months
RTR-505-P	About 10 months

- The battery warning mark may appear sooner than noted above.
- Battery life will be shortened when: downloading data very often, setting the recording interval at less than ten seconds, or measuring in an environment below -20°C (-4°F) or above 60°C (140°F).
- **Notes about Changing the Battery**
- Before replacing a battery, please make sure to download any necessary data and proceed with changing the battery.
- If + (plus) and - (minus) are mistaken, or if the battery terminals + and - are shorted, the recorded data that is stored in the Unit will be lost.
- Downloading of data cannot occur while the battery is removed.

Example of Display

Display varies depending upon the model being used.

RTR-505-TC (Thermocouple)



Temperature measurement (Unit: °F / °C) will be displayed. Sensor type will be displayed under the measurement; the factory default setting is Type K. By using the software included with the Base Unit, you can change the sensor type.

RTR-505-Pt (Pt100 / Pt1000)



Temperature measurement (Unit: °F / °C) will be displayed. Sensor type will be displayed under the measurement; the factory default setting is Pt100. By using the software included with the Base Unit, you can change the sensor type.

RTR-505-V (Voltage)



Voltage measurement (Unit: V / mV) will be displayed. Due to the wide measurement range, the Unit has been set by default to adjust the decimal point automatically to display the measurement in V. By using the software included with the Base Unit, you can change the unit of display.

RTR-505-mA (4-20mA)



4-20mA measurement (Unit: mA) will be displayed.

3. How to Read the LCD Display (continued from previous page)

RTR-505-P (Pulse)

There are two display methods for the pulse measurement. By using the software included with the Base Unit, you can change the display method.



Pulse Rate (Max: 61439)

The most recent pulse count (Unit: P) for the recording interval period will be displayed. The display will be refreshed every one-sixtieth of the recording interval (at minimum of every one second). 10,000 pulse count will be displayed as "10.00KP", in units of 10 pulse for display.



Total Pulse Count

The cumulative number of pulses (Unit: P) will be displayed from 0 to 9999. The displayed count will be refreshed every one second, and upon exceeding 9999, the count will start over again from 0.

Other Marks or Messages on Display

Logging Capacity FULL



When Recording Mode has been set to "One Time" and the Unit reaches its logging capacity of 16,000 readings, recording will automatically stop and in the LCD the measurement and the word "FULL" will alternately appear.

Estimation of time until "FULL" is displayed

Recording Interval	1 second	30 seconds	1 minutes	10 minutes	60 minutes
Period	About 4 hours	About 5 days	About 11 days	About 111 days	About 1 year and 10 months

Data Transmission via Wireless Communication



The measurement and the word "SEnd" will alternately appear when data is being sent via wireless communication to the Base Unit. Recording will continue during wireless transmission.

Check

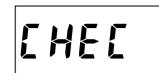

If this appears, all data that was stored in the Unit will have been erased. This message will appear under the following conditions:

- The first time a battery was inserted after purchase
- When the battery is replaced after having been taken out for a long period
- When the battery is replaced after the battery power has been lost

Input Module Unrecognized (factory default)

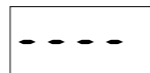

This will appear if, after purchasing, the Input Module has never been connected to the Unit. (No unit for display)

Note that a RTR-505-P has been set to measure Pulse by default, therefore the unit "P" will be displayed.

Input Module Unconnected or Damaged

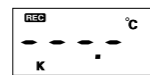

This will appear if the Unit cannot confirm a connection with the Input Module after having recognized it. (with unit of display)

If nothing is displayed after reconnecting the sensor to the Unit, there is a possibility that the sensor or the Unit has been damaged.

Sensor Unconnected or Damaged

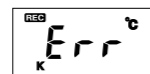

This will be displayed when a sensor has not been connected to the module or the wire has been broken. Recording is in progress and so is battery consumption.

If nothing appears on display after reconnecting the sensor to the Unit, there is a possibility that the sensor or the Unit has been damaged.

Measurement Range Exceeded

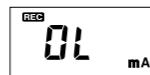

The message "OL" will appear if a measurement exceeds the measurement range.

Display Range Exceeded

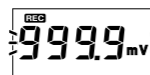

When measuring voltage in "mV range", the measurement in the LCD display will flash if it exceeds the display range of the Unit.

4. Registering as a Remote Unit (Communication with a PC)

In order to download data from the Unit via wireless communication or change recording settings in the Unit, it is necessary to register a RTR-505 Unit as a Remote Unit to a Base Unit (sold separately). Remote Unit registration can be carried out by connecting the Base Unit to a PC via USB cable and using the software included with the Base Unit to carry out optical communication with the Remote Unit.

For details about available operations via wireless communication or how to make recording settings, see the Introductory Guide included with the Base Unit or see the application's Help.

Communicating with the Computer

1. Follow directions as issued in the software to connect the Base Unit to your PC.

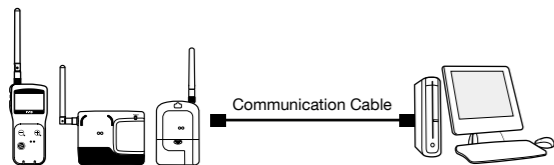

2. Place the Data Logger on the Base Unit to align the optical communication areas and slitted areas.

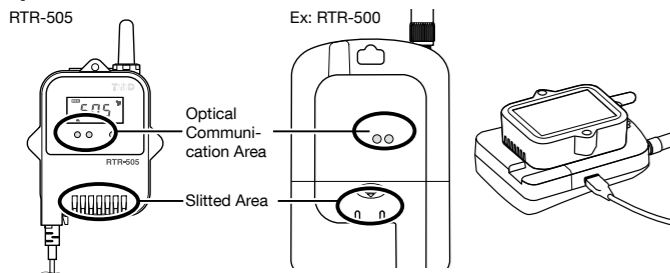

Communication with a PC enables the following:

By using a software included with the Base Unit, it is possible to carry out Remote Unit registration, change recording settings in the Unit, download recorded data to a PC, and view downloaded data.

The factory default settings are as follows: Recording Interval: 10 minutes, Recording Start: Immediate Start, and Recording Mode: Endless.

Notices about Optical Communication with a Base Unit

- Proper communication may not be possible in the following situations: where temperatures are very high or very low, in an environment with intense brightness (higher than 5,000lx), or when the remaining battery life for the Data Logger is very low.
- The time necessary to download one RTR-505 Unit at full logging capacity varies depending upon the Base Unit being used.

Important Notices and Disclaimers

In order to properly use this product, please carefully read this manual before using.

- All rights of this manual belong to T&D Corporation. It is prohibited to use, duplicate and/or arrange a part or whole of this Manual without the permission of T&D Corporation.
- All registered trademarks, company names, product names and logos mentioned herein are the property of T&D Corporation or of their respective owners.
- Specifications, design and other contents outlined in this manual are subject to change without notice.
- Please follow the safety precautions outlined in this manual carefully. We cannot guarantee nor are we responsible for safety if this product is used in any manner other than was intended.
- On-screen messages in this manual may vary slightly from the actual messages.
- Please notify the shop where you purchased this product or T&D Corporation of any mistakes, errors or unclear explanations in this manual.
- T&D Corporation accepts no responsibility for any damage or loss of income caused by the use of our product.
- This product has been designed for private or industrial use only. It is not for use in situations where strict safety precautions are necessary such as in connection with medical equipment, whether directly or indirectly.
- We are not responsible for any malfunction or trouble caused by the use of our product or by any problem caused by the use of measurement results of our unit. Please be fully aware of this before using our product.
- This manual cannot be reissued, so please keep it in a safe place.
- Please read the warranty and provisions for free repair carefully.

Safety Precautions and Instructions

* Please carefully observe the following safety measures when using our product.

To prevent any loss or damage to our customers, other people and/or property, and to ensure the proper use of our products we ask that before using our product you carefully read, understand and follow the safety rules and precautions for our products as outlined below.

⚠ DANGER

- ⚠ Do not take apart, repair or modify the Unit. It may result in malfunction or unexpected accidents.
- ⚠ Do not use any other batteries than those that are specified in this manual. It may cause fire or malfunction.
- ⚠ If water or a foreign object enters the case, immediately remove the battery and cease using it. It may result in malfunction or unexpected accidents.
- ⚠ Store the Unit and accessories out of the reach of children. Not doing so may cause an unexpected accident.
- ⚠ If any smoke or strange smells are emitted from the Unit, immediately remove the battery and stop using. Continued use may cause fire or electrocution.
- ⚠ Please be careful not to touch the Unit during or after use in overly hot or cold environments; it may cause burns or frostbite.

⚠ CAUTION

- ⚠ This Unit has been designed for private and/or industrial use only. It is not for use in situations where strict precautions are necessary such as in connection with medical equipment, where directly or indirectly.
- ⚠ Harmful gases or chemicals may cause corrosion and/or other danger to the Unit. Also, by coming in contact with hazardous substances, harm may occur to the people handling the Unit. Therefore, do not use or store the Unit in any environment that is exposed to chemicals and harmful gases.
- ⚠ Battery life varies depending upon measuring environment, frequency of communication, Unit settings, and battery performance.
- ⚠ When using the Unit in a low-temperature environment (below -20°C), the battery power will be depleted more quickly than when using under normal temperature conditions.
- ⚠ Battery terminals may provide insufficient contact due to age or vibration. This may lead to data loss.
- ⚠ The Unit becomes splash proof (rated for use in daily life) only after the Input Module has been connected. Without the module connected, neither the module jack nor the connector part of the temperature sensor on the Unit is water resistant; make sure not to get wet.
- ⚠ If the Unit is not to be used for a long period of time, store it in a place where it is not exposed to high temperature and high humidity. If the Unit has condensation on the inside, it may cause malfunction and damage.
- ⚠ Do not remove or reinsert the battery once it has been set; continue using until battery power is depleted. Always use a new battery for replacement. Not doing so may result in improper operation.
- ⚠ To maintain waterproof capacity, we suggest periodically changing the parts inside the case. If the rubber packing should be damaged or deteriorated, please replace it along with the drying agent.
- ⚠ If the Unit is subjected to significant temperature change while wet, it may cause condensation inside the case. Especially be careful with temperature changes from high to low; if the Unit has condensation on the inside, it may cause malfunction, damage, and/or unexpected accidents.
- ⚠ Do not drop or expose the Unit to a strong impact. It may cause damage or malfunction.
- ⚠ Do not put fingers or foreign objects into the modular jack.
- ⚠ Do not use or store the Unit in places such as listed below. It may result in malfunction or unexpected accidents.
 - Areas exposed to direct sunlight
 - Areas exposed in water or high-pressure water flow
 - Areas exposed to organic solvents and corrosive gas
 - Areas exposed to strong magnetic fields
 - Areas exposed to static electricity
 - Areas near fire or exposed to excessive heat
 - Areas exposed to excessive dust, dirt and smoke

⚠ Contact with oil may cause cracks to appear in the casing of the Unit. When using this Unit in environments where such oils are present, please insure that it is protected from contact through use of a polyethylene bag or other means.

⚠ Notices about using the Input Modules

When making "Adjustment Settings" in the Adjustment Tools application, the adjustment values will be saved to the Input Module. Therefore, when an Input Module is replaced, it is necessary to re-make any desired adjustment settings to be written into the newly connected module.

⚠ Compliance Information

CE Statement

The RTR-500 Series products are in compliance with the Radio Equipment Directive 2014/53/EU.

The following standards have been applied:

<Safety and Health>	EN 60950-1
	EN 50663
<EMC>	EN 301 489-1
	EN 301 489-3
<Radio Spectrum>	EN 300 220-2 (receiver category 2)

The full text of the EU declaration of conformity is available at the following internet address:

http://cdn.tandd.co.jp/glb/manual/DoC_RTR500_Series.pdf

⚠ Important Notice

Wireless products cannot be used in countries other than where those products have been approved for use, according to that country's wireless regulations. T&D Corporation shall in no manner whatsoever take responsibility for the usage of these products, nor be liable in any manner for legal consequences stemming from the usage of these wireless products in unapproved areas.